



芯善物科技

MPSA65M990, MPSP65M990, MPSU65M990, MPD65M990

Specifications $T_J = 25^\circ\text{C}$, unless otherwise noted						
Parameter	Symbol	Test Conditions	Value			Unit
			Min.	Typ.	Max.	
Static						
Drain-Source Breakdown Voltage	$V_{(BR)DSS}$	$V_{GS} = 0V, I_D = 250\mu A$	650	--	--	V
Zero Gate Voltage Drain Current	I_{DSS}	$V_{DS} = 650V, V_{GS} = 0V, T_J = 25^\circ\text{C}$	--	--	1	μA
		$V_{DS} = 650V, V_{GS} = 0V, T_J = 150^\circ\text{C}$	--	--	100	
Gate-Source Leakage	I_{GSS}	$V_{GS} = \pm 30V$	--	--	± 100	nA
Gate-Source Threshold Voltage	$V_{GS(th)}$	$V_{DS} = V_{GS}, I_D = 0.25mA$	2.5	--	4.5	V
Drain-Source On-Resistance (Note3)	$R_{DS(on)}$	$V_{GS} = 10V, I_D = 2A$	--	0.88	0.99	Ω
Gate Resistance	R_G	$f = 1.0MHz, \text{open drain}$	--	14	--	Ω
Dynamic						
Input Capacitance	C_{iss}	$V_{GS} = 0V, V_{DS} = 100V, f = 1.0MHz$	--	306	--	pF
Output Capacitance	C_{oss}		--	12	--	
Reverse Transfer Capacitance	C_{rss}		--	2	--	
Total Gate Charge	Q_g	$V_{DD} = 400V, I_D = 4A, V_{GS} = 10V$	--	8.8	--	nC
Gate-Source Charge	Q_{gs}		--	1.5	--	
Gate-Drain Charge	Q_{gd}		--	4.2	--	
Turn-on Delay Time	$t_{d(on)}$	$V_{DD} = 400V, I_D = 4A, V_{GS} = 10V, R_G = 25\Omega$	--	36	--	ns
Turn-on Rise Time	t_r		--	27	--	
Turn-off Delay Time	$t_{d(off)}$		--	80	--	
Turn-off Fall Time	t_f		--	25	--	
Drain-Source Body Diode Characteristics						
Continuous Body Diode Current	I_S	$T_C = 25^\circ\text{C}$	--	--	4	A
Pulsed Diode Forward Current	I_{SM}		--	--	8	
Body Diode Voltage	V_{SD}	$T_J = 25^\circ\text{C}, I_{SD} = 4A, V_{GS} = 0V$	--	0.9	1.2	V
Reverse Recovery Time	t_{rr}	$V_R = 400V, I_F = 4A, di_F/dt = 100A/\mu s$	--	240	--	ns
Reverse Recovery Charge	Q_{rr}		--	1.1	--	μC
Peak Reverse Recovery Current	I_{rrm}		--	9	--	A

Notes

1. Repetitive Rating: Pulse width limited by maximum junction temperature
2. $I_{AS} = 2A, V_{DD} = 50V, R_G = 25\Omega, \text{Starting } T_J = 25^\circ\text{C}$
3. Pulse Test: Pulse width $\leq 300\mu s, \text{Duty Cycle } \leq 1\%$

Typical Characteristics $T_J = 25^\circ\text{C}$, unless otherwise noted

Figure 1. Output Characteristics ($T_J = 25^\circ\text{C}$)

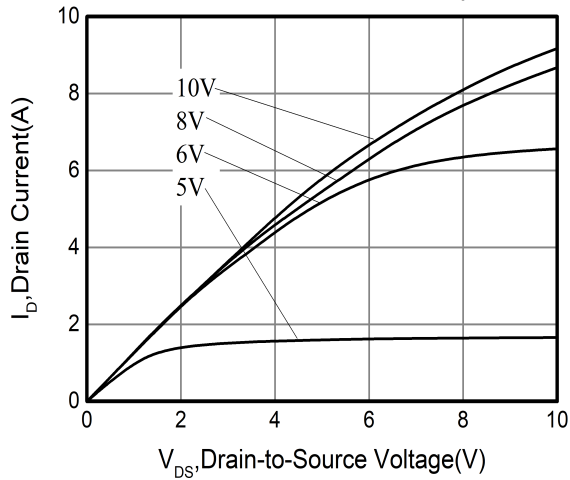

Figure 2. Transfer Characteristics

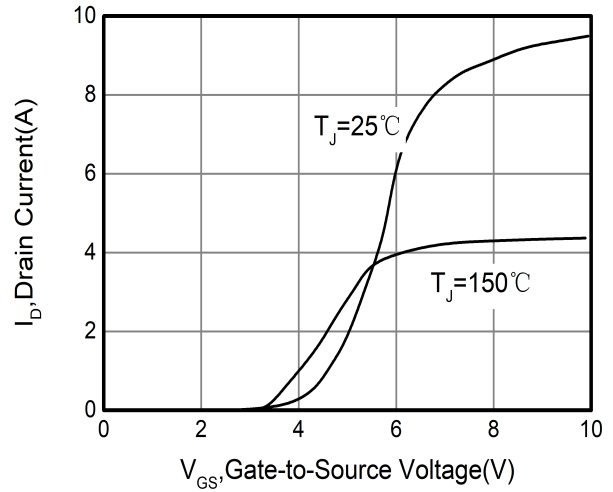

Figure 3. On-Resistance vs Drain Current

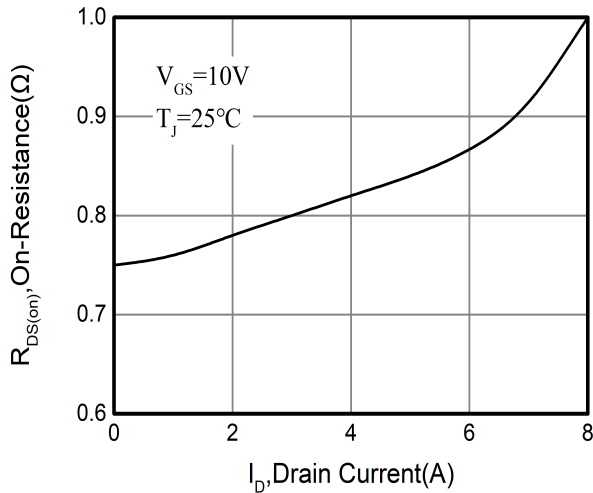

Figure 4. Capacitance

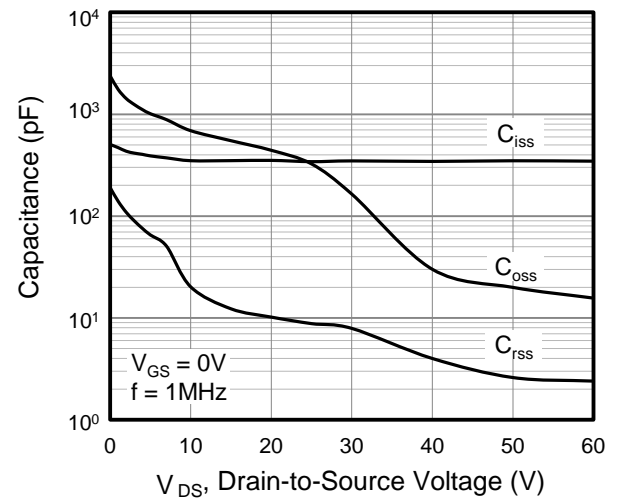

Figure 5. Gate Charge

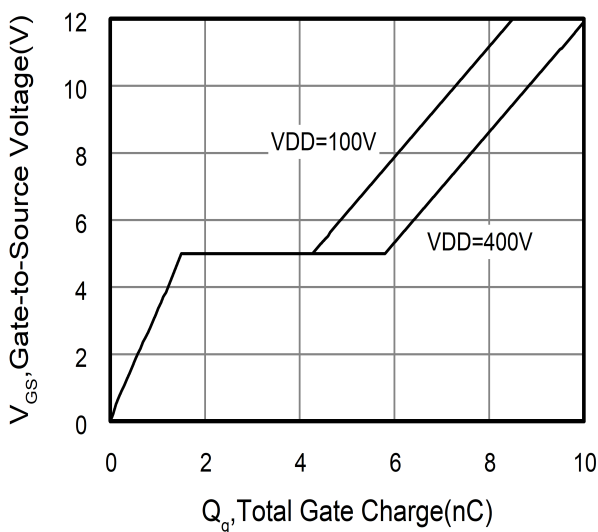
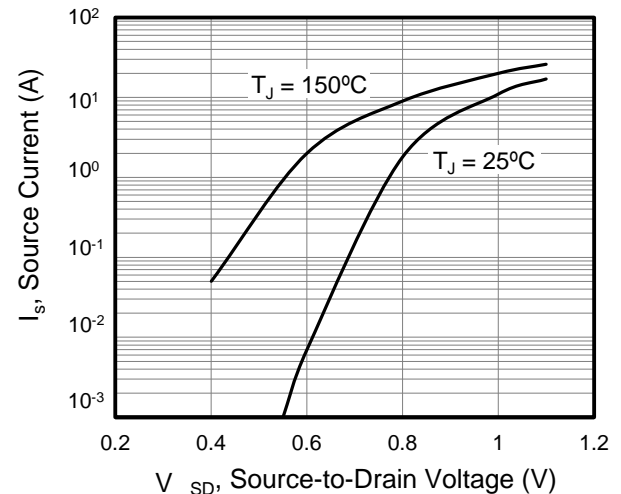

Figure 6. Body Diode Forward Voltage



Typical Characteristics $T_J = 25^\circ\text{C}$, unless otherwise noted

Figure 7. On-Resistance vs. Junction Temperature

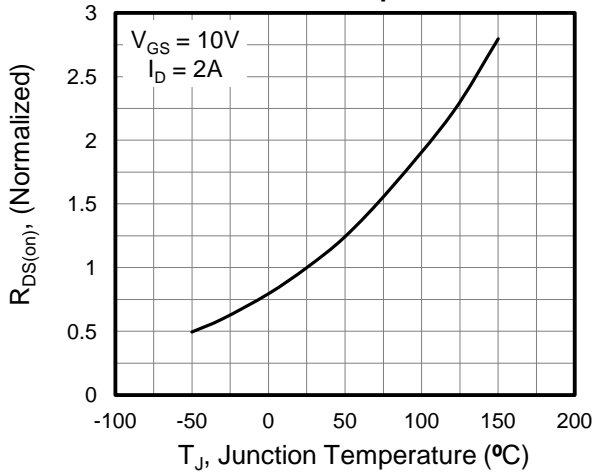

Figure 8. Threshold Voltage vs. Junction Temperature

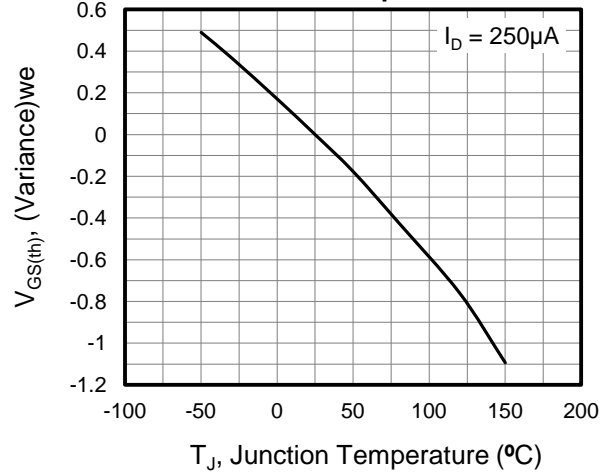

Figure 9. Transient Thermal Impedance TO-251, TO-252, TO-220

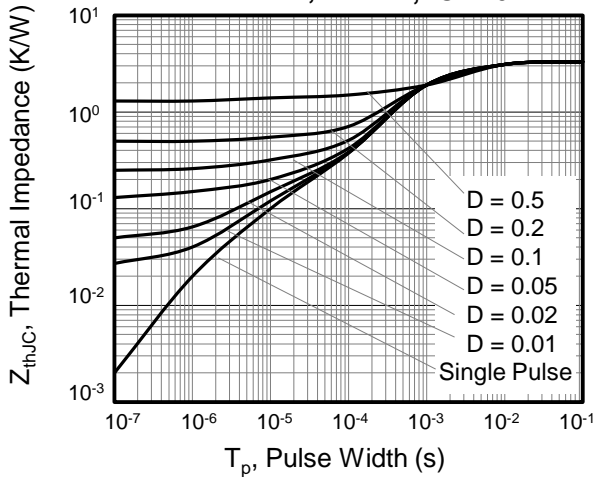

Figure 10. Transient Thermal Impedance TO-220F

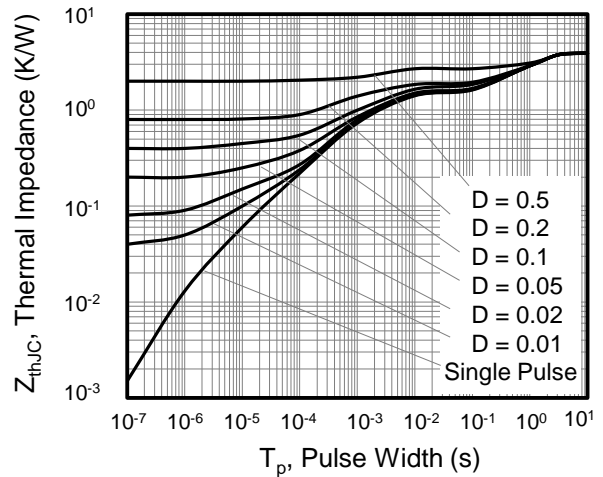

Figure A: Gate Charge Test Circuit and Waveform

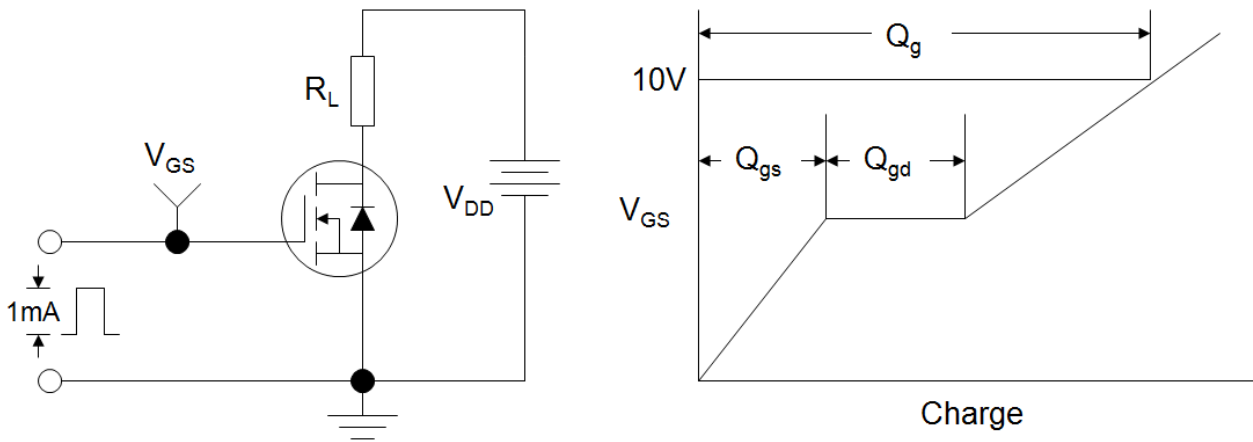

Figure B: Resistive Switching Test Circuit and Waveform

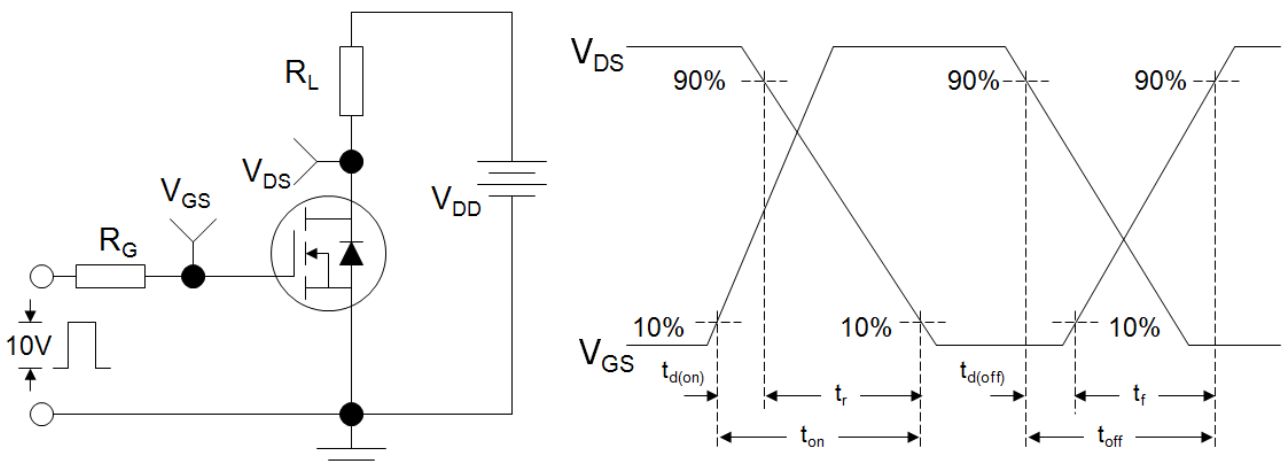
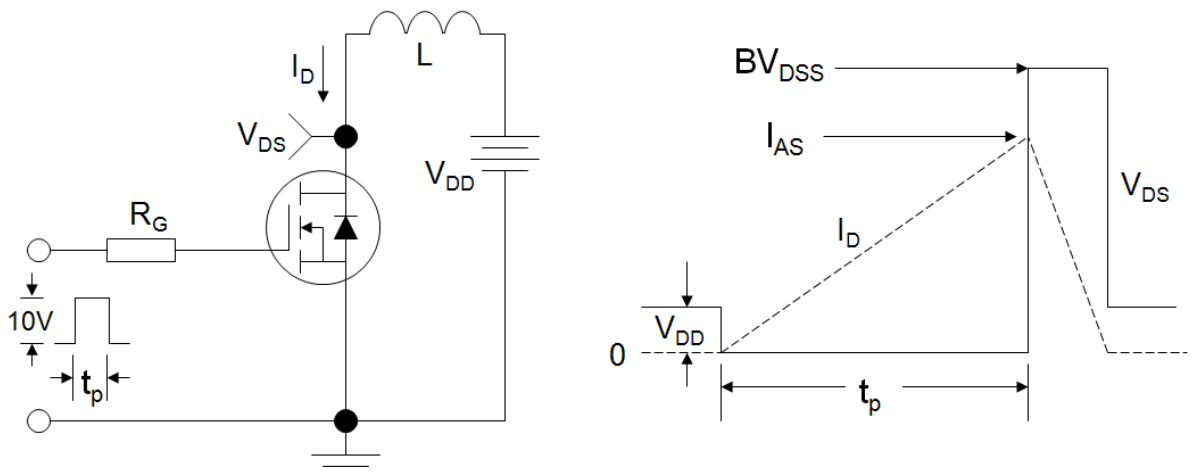
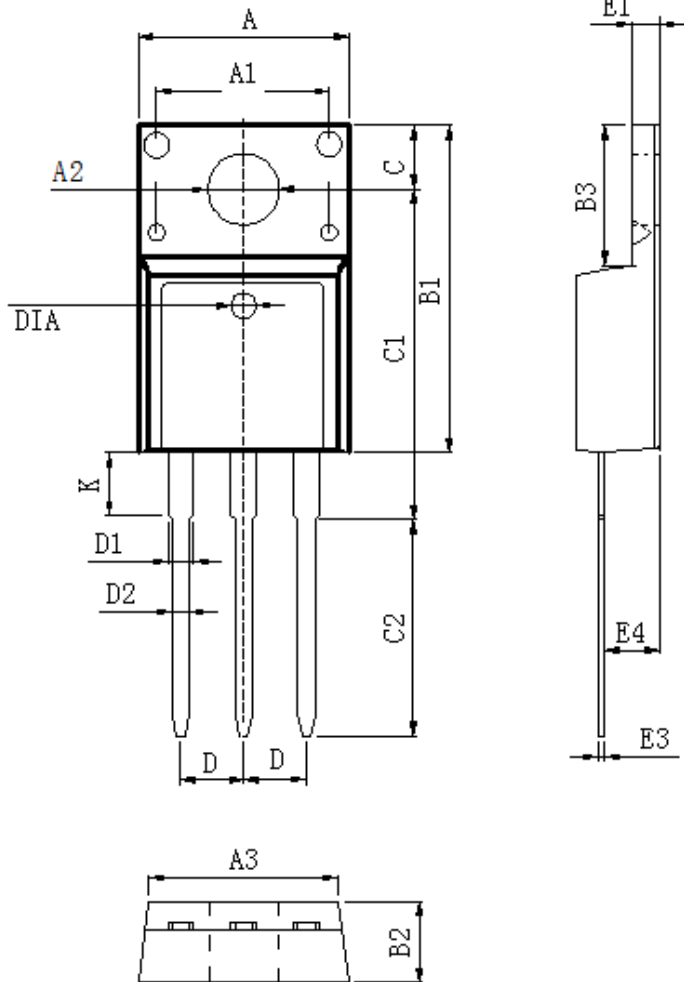

Figure C: Unclamped Inductive Switching Test Circuit and Waveform



TO-220F



DIM	MILLIMETERS
A	10.16 ± 0.3
A1	7.00 ± 0.1
A2	3.3 ± 0.2
A3	9.5 ± 0.2
B1	15.87 ± 0.3
B2	4.7 ± 0.2
B3	6.68 ± 0.4
C	3.3 ± 0.2
C1	12.57 ± 0.3
C2	10.02 ± 0.5
D	2.54 ± 0.05
D1	1.28 ± 0.2
D2	0.8 ± 0.1
K	3.1 ± 0.3
E1	2.54 ± 0.1
E3	0.5 ± 0.1
E4	2.76 ± 0.2
DIA	$\odot 1.5$ (deep 0.2)

Unit :mm

TO-220

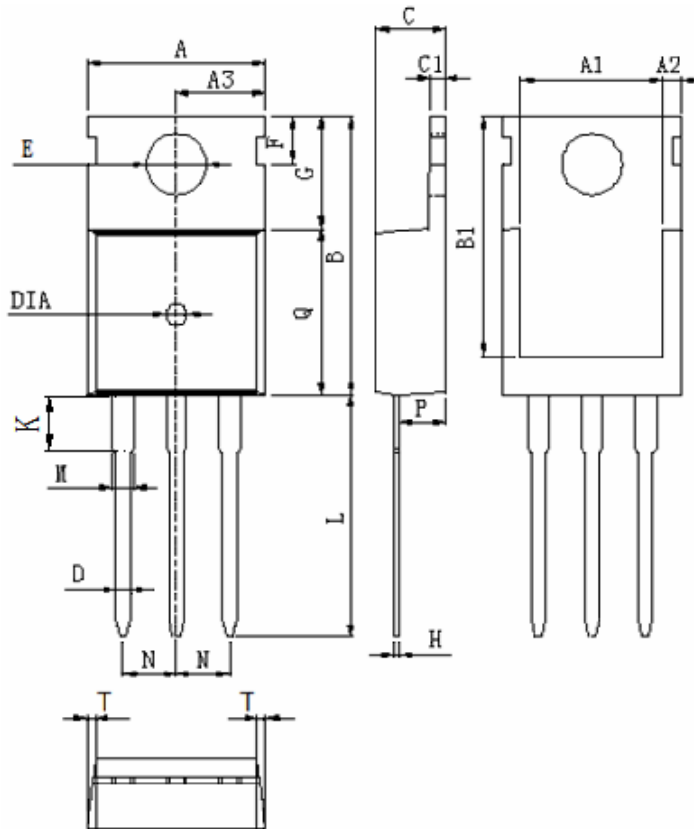

DIM	MILLIMETERS
A	10.0±0.3
A1	8.64±0.2
A2	1.15±0.1
A3	5.0±0.2
B	15.8±0.4
B1	13.2±0.3
C	4.56±0.1
C1	1.3±0.2
D	0.8±0.2
E	3.6±0.2
F	2.95±0.3
G	6.5±0.3
H	0.5±0.1
K	3.1±0.2
L	13.2±0.4
M	1.25±0.1
N	2.54±0.1
P	2.4±0.3
Q	9.0±0.3
T	W:0.35
DIA	⊙1.5 (deep 0.2)

Unit :mm

TO-251

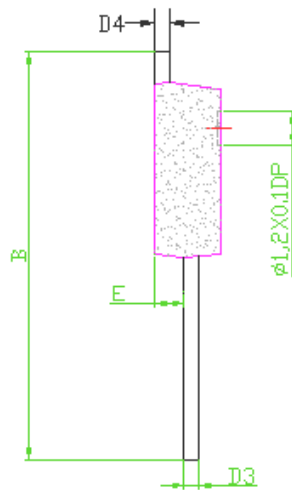
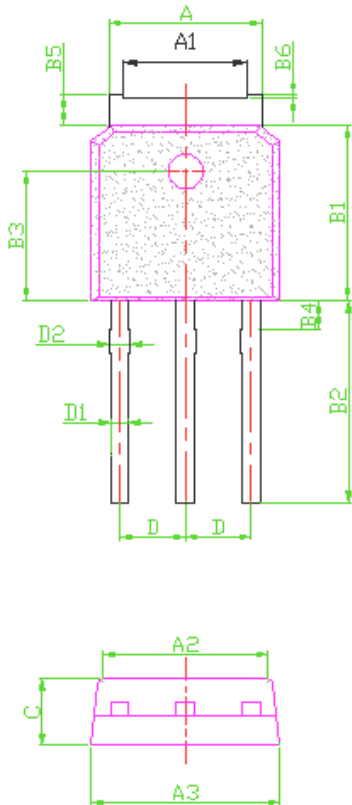

DIM	MILLIMETERS
A	5.33 ± 0.2
A1	4.33 ± 0.2
A2	5.80 ± 0.1
A3	6.6 ± 0.2
B	14.15 ± 0.5
B1	6.1 ± 0.3
B2	7.0 ± 0.5
B3	4.5 ± 0.15
B4	1.0 ± 0.1
B5	1.05 ± 0.1
B6	0.1 ± 0.05
C	2.3 ± 0.2
D	2.286 ± 0.05
D1	0.60 ± 0.1
D2	0.72 ± 0.12
D3	0.5 ± 0.08
D4	0.5 ± 0.08
E	1.01 ± 0.2
DIA	$\odot 1.2$ (deep 0.1)

Unit :mm

TO-252

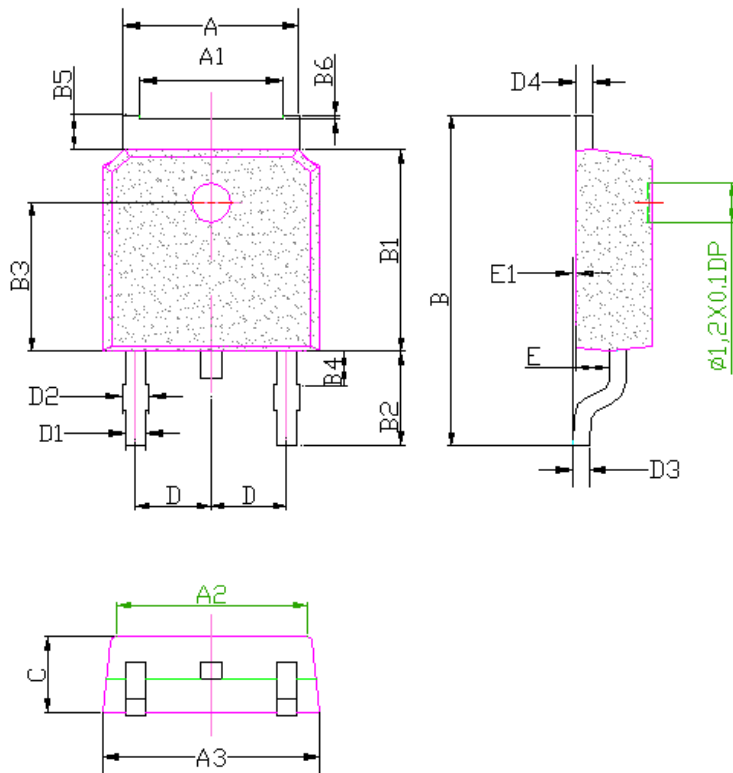

DIM	MILLIMETERS
A	5.33 ± 0.2
A1	4.33 ± 0.2
A2	5.80 ± 0.1
A3	6.6 ± 0.2
B	10 ± 0.5
B1	6.1 ± 0.3
B2	2.85 ± 0.5
B3	4.5 ± 0.15
B4	1.0 ± 0.1
B5	1.05 ± 0.1
B6	0.1 ± 0.05
C	2.3 ± 0.15
D	2.286 ± 0.05
D1	0.60 ± 0.1
D2	0.72 ± 0.12
D3	0.5 ± 0.08
D4	0.5 ± 0.08
E	1.01 ± 0.15
E1	0.1 ± 0.05
DIA	$\odot 1.2$ (deep 0.1)

Unit :mm